

Horizon

 iCE Series

FOLDING

iCE FOLDER

AFV-56S / TV-56S Series

Next Generation Folder

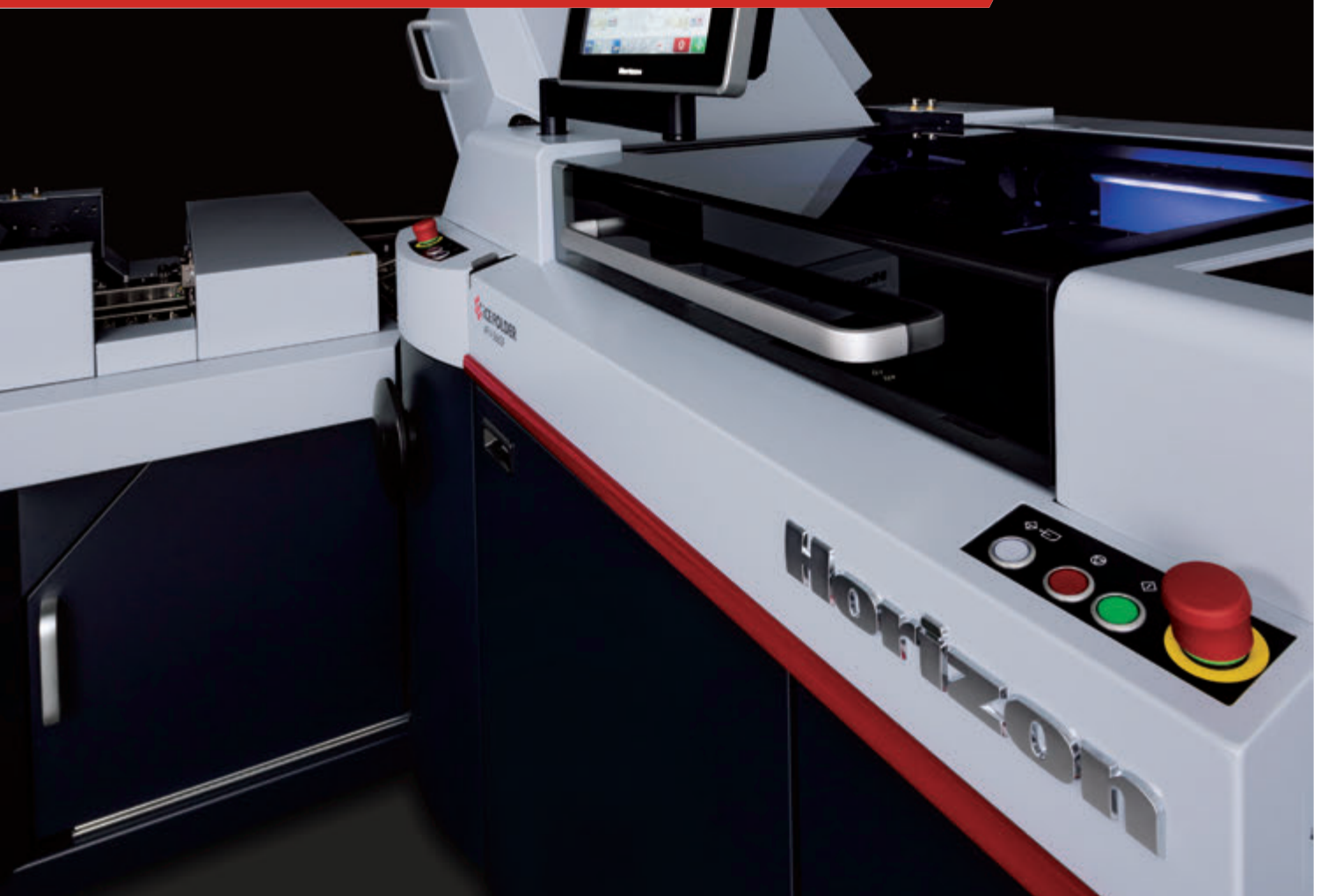



i = Intelligence, Integration, Interaction
C = Connection
E = Efficiency

All Connected...

Optimize your finishing process with automation and workflow.

The iCE series is a new product line-up which is designed to provide added value to our customers. A new operator interface for a more intuitive operation. Advanced automation to provide increased efficiency and productivity. In addition, connecting with an iCE LiNK workflow system provides a totally connected work environment.

INCREASED PRODUCTIVITY WITH THE HIGHEST LEVEL OF AUTOMATION.

Newly added functions enable easy operation and maximizes quality and productivity.

BENEFITS

EASY SETUP

Icon based touchscreen provides quick and easy setup without any manual adjustment. Fully-automated setup enables any operator to produce consistent, high quality folds with efficiency and high productivity.

HIGH PRODUCTIVITY

Advanced automation technology reduces set-up time dramatically. High speed production is achieved with belt speeds of 270 m / min.

APPLICATION FLEXIBILITY

Flexible machine configurations and a variety of options allow for a wide range of applications.

STATUS RECOGNITION

The LED lights in the AFV-56S indicate the operational status by switching colors to identify the system status at a glance. The lights serve as white working lights when the cover is open. The color of the lights can be chosen from the touch panel.

MANAGE YOUR BINDERY WITH HORIZON'S BINDERY CONTROL SYSTEM

The system can be enhanced with automated workflow from upstream to post-press with iCE LiNK, which uses cloud technology, Horizon's post-press management system.





ICE FOLDER AVF-566SF + TV-566SF + PST-44L

APPLICATION FLEXIBILITY

- A wide variety of fold patterns can be set up automatically by selecting the icons on the touch screen.
- *Non-standard fold patterns can also be set up automatically by entering the setup size for each fold.
- More fold patterns are available by connecting with the TV-56S series as a second station.

Stand-alone 6 or 4-buckle Model (AVF-566S/564S series)	Single Fold	Accordion Fold	Zigzag Fold (4 panel)	Zigzag Fold (5 panel)	Zigzag Fold (6 panel)*1	Zigzag Fold (7 panel)*1	Short Fold	Letter Fold	Double Parallel Fold (4 panel)	Round Parallel Fold (4 panel)*2	Single Fold + Double Parallel Fold*2	Gate Fold

*1: Not available with the AVF-564SF/SA.

*2: Sheet size should be input manually with the AVF-564SF/SA.

KEY FEATURES FOR MORE PRODUCTIVITY.

Advanced automation to bring your operation to the next level.

ADJUSTMENT FOR SKEWED FOLDS **AFV-566SF/SA, AFV-564SF/SA**

- The sheet register guide angle and buckle plates are automatically set by entering the sheet size and fold pattern at the touch-screen. With automated guide angle adjustment precise folds can be produced without highly skilled or experienced operators.



ROLLER GAP ADJUSTMENT **AFV-566SF/564SF**

- All fold roller gaps are automatically set by inserting a single strip of paper. Gap setting is completed according to the sheet thickness and fold pattern. Set-up time is greatly reduced with the elimination of sheet insertion for each roller gap.
- Fine-adjustment of all fold roller gaps is possible in a micron unit via the touch-screen.

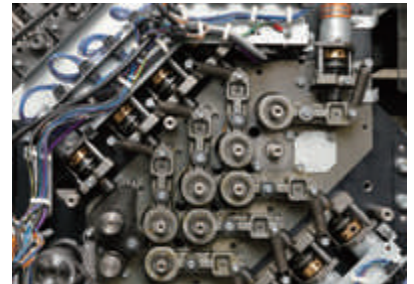

AUTOMATED REGISTER CONVEYOR **AFV-566SF/SA, AFV-564SF/SA**

- The vacuum register guide sets automatically according to the sheet width. Sheets are properly aligned to the guide for folding accuracy.
- Five vacuum chambers adjust automatically for sheet length, and coated or uncoated surface. The vacuum can be adjusted individually based on sheet condition and the setting can be memorized for easy recall.
- Efficient blower motors insure long lasting performance and energy efficiency.



RIGHT-ANGLE REGISTER CONVEYOR **TV-566SF/SA, TV-564SF/SA**

- Conical drive rollers are used for accurate sheet registration with minimal adjustment required.



SCORING NAVIGATOR **AFV-566SF/564SF**

- Scoring navigator allows operator to adjust accurate scoring and perforation positioning with easy setup procedure.
- Scoring position can be adjusted incrementally by 0.1 mm.
- Settings can be saved to memory for recall on reoccurring jobs.



BRIDGE CONVEYOR (BGV-56 / BGV-56BBS) Option

- Bridge conveyor is on a slide rail for easy access to the scoring shafts.
- Smooth transfer of sheets to the 2nd fold section, presser stacker or delivery conveyor.
- The BGV-56BBS automatically adjusts to maintain center registration at the BBS-40 book block stacker.



DYNAMIC FOLD Option

Optional dynamic buckle plate is available for changing the fold patterns on-the-fly for book production. For example, 12 page and 8 page signatures can be produced consecutively to reduce blank pages in the book.

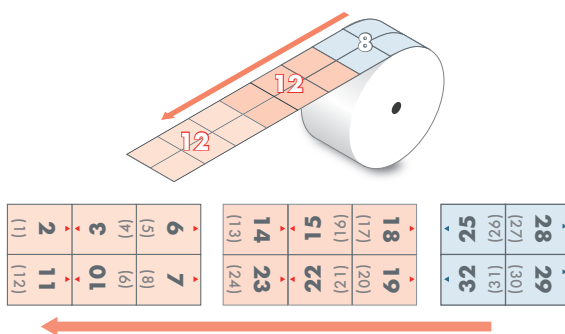

ADVANCED AUTOMATION FOR EASY SETUP

ITEMS FOR AUTOMATED SETUPS	DESCRIPTIONS	FIRST STATION		SECOND STATION			
		AFV-566SF AFV-564SF	AFV-566SA AFV-564SA	TV-566SF TV-564SF	TV-566SA TV-564SA		
Feeder Section	Suction Head	Suction head moves to feeding position according to the sheet length.		Yes	No	No	No
	Table Guide	Table guide moves to the proper loading position according to sheet width.		Yes	Yes	No	No
	Vacuum Register Belt	Vacuum register belt moves together with register guide. Sheets align to guide by vacuum. Vacuum level can be adjusted and sets automatically according to sheet quality.		Yes	Yes	No	No
	Sheet Register Guide	Register guide moves to proper position according to sheet width.		Yes	Yes	No	No
	Sheet Edge Guide	Sheet edge guide sets to proper position to support sheet edge for smooth sheet transport.		Yes	Yes	No	No
	Register Guide Angle	Register guide angle can be adjusted from - 4 mm to + 4 mm.		Yes	Yes	No	No
	Sheet Hold-down Guide	Sheet hold-down guide adjusts to sheet width for smooth sheet transfer to fold section.		Yes	Yes	No	No
Fold Section	Roller Gap	Roller gap sets up automatically by inputting the single sheet into the caliper.		Yes	No	Yes	No
	Buckle Stopper	The buckle stopper position is set automatically depending on the sheet size and fold pattern.		Yes	Yes	Yes	Yes
	Scoring Position	Score roller position is located automatically based on sheet width and fold pattern.		Yes	No	No	No
Right Angle Conveyor	Register Guide	Sheet register guide sets automatically according to fold pattern at 1st unit.		No	No	Yes	Yes
	Sheet Hold-down Guide	Sheet hold-down guides adjust for smooth transfer of sheets to 2nd fold section.		No	No	Yes	Yes

DETAILS FOR EACH SECTION.



ice FOLDER AFV-566SF + TV-566SF + PST-44L

1 TOUCH PANEL DISPLAY



The 12.1 inch color touch-screen is icon-based for user-friendly operation. Set-up and operation can be done at the touchscreen. Up to 999 job settings can be stored in job memory. The job settings saved in the previous model, AFV-56 can be transferred to this model.

Remote Controller

Wired remote controller with jog dial allows for start, stop feeding and test feeding from a remote position. Fine tuning of all automated settings is also possible via the remote control.

2 SUCTION HEAD / ASSIST AIR



Newly designed suction head and feeding system enables easy setup and consistent feeding. Innovative suction head and assist air* provide accurate sheet separation and pick-up. Blowing air volume and height of the suction head can be adjusted according to the sheet condition for stable feeding for a wide variety of printed materials.

*The assist air kit SAB-56V with adjustable nozzle height is available as an option.

3 FEED ROTOR



Quality polyurethane rotor provides high speed feeding without scratching. The suction angle adjustment enables stable feeding by adjusting the angle of suction air according to the sheet condition. The supersonic and photoelectric double feed detect sensors come standard for superior double feed protection.

Supersonic Sensor

The supersonic double feed sensor works through the transmission of sound waves. Its advanced detection ensures accurate double feed detection even with a solid black printed sheet.

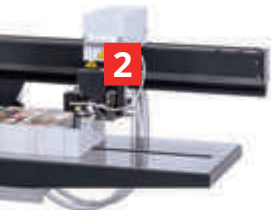

2

5 FOLD ROLLERS

Unique design and precision manufacturing insure folding accuracy and long roller life. Soft or hard urethane rollers are available depending upon folding requirements.



RL-566VS/RL-564VS
Soft Urethane Roller



RL-566VH1/RL-564VH1
Hard Urethane Roller

4 SHEET REGISTER GUIDE AFV-566SF/564SF



The register guide is coated with a special anti-static plating, for trouble-free folding of printed sheets, even in dry climates, where static can be a problem. The register guide ensures stable transportation and accurate registration of a wide range of paper stocks. Newly added cover provides noise reduction and safe operation. All the sections set-up automatically and the operator does not need to open the cover for the change over process. Newly designed sheet control reduces waste when a feed error happens. Mis-fed sheets are stopped prior to entering the fold section for easy operator removal.

6 BUCKLE PLATES



Uniquely designed buckle plate enables improved folding accuracy and consistency for a wider range of substrates, including thin or light weight sheets. Specially-coated buckle plates minimize paper friction to maintain fold accuracy. When feeding from a printed roll, the uniquely designed automatic gate mechanism of dynamic buckle plate enables changing fold patterns on the fly.



B-56V
Straight Deflector Buckle Chute

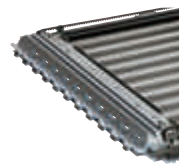

B-56C
Comb Shape Deflector Buckle Chute

7 PERFORATION / SCORING

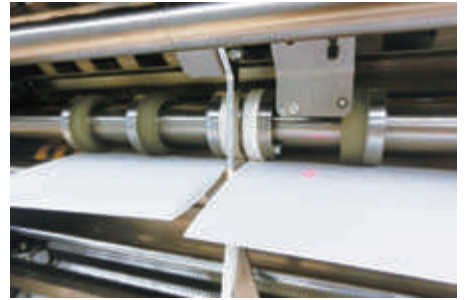

Perforation, slit perforation, scoring and slitting can be performed. Durable scoring unit is employed for accurate scoring. Optional devices are available for strip trimming of multiple-up jobs, trimming the closed side of glued signatures and punch perforation. Scoring navigator allows operator to adjust accurate scoring and perforation position. Up / down scoring and drive roller positions are indicated on the touch screen. Set-up time for scoring is greatly reduced even for inexperienced operators.

*Optional strip trim unit AF-ST5N is attached in the photo.

8 BRIDGE CONVEYOR

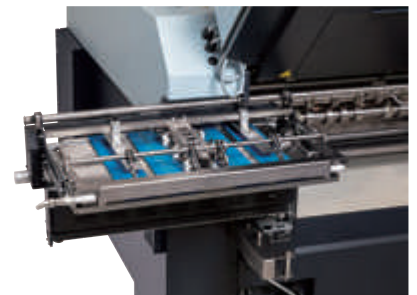

The unit slides outside for easy score position adjustment.

9 RIGHT-ANGLE REGISTER CONVEYOR



Auto adjusting conveyor and guides with conical drive rollers efficiently transfers even complex folded sheets to the 2nd fold section.

OPTIONS.

Available options to extend capabilities.

SSK-56V SMALL SIZE KIT

- Minimum 105 mm or 4.13" width sheet can be fed. (Standard: 128 mm or 5.04")
- The side air will be used for feeding instead of the suction head.

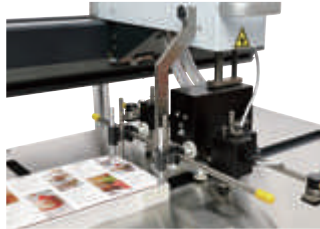

SAB-56V SIDE AIR BLOWER

- Side air nozzle sets according to the height of sheets on the feeder for more accurate sheet separation and pick-up.
- Increased air control for small format and light weight sheets.



LT-56V EXTENSION TABLE

- The feed table and suction head are extended for sheets up to 1,100 mm or 43.31" length. (Standard: 900 mm or 35.43")

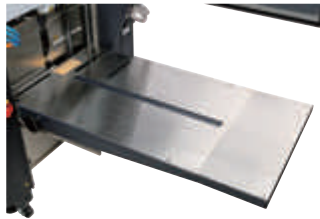

AI-56V AIR INTEGRATION KIT

- The air is provided directly from the air supply of the factory via this integration kit. The installation of the pump is not required.



P-56V / 56VSH / 56VUL / 56VX PUMP

- The pump is selectable to suite with the customers' requirements.



P-56VX
Long-life type



P-56VSH
Noise reduction cover attached

FEEDER SECTION

●: Retrofittable Options

NAME		MODEL	DESCRIPTIONS	AFV-566SF	AFV-564SF	AFV-566SA	AFV-566SA
Selection	Pump	P-56V	Pump for CE.	●	●	●	●
		P-56VUL	Pump for UL.	●	●	●	●
		P-56VSH	Noise reduction cover is attached. (*-6 dB reduction)	●	●	●	●
		P-56VX	Long-life type (Blades are about three times* more durable than P-56V.) *Depends on the condition.	●	●	●	●
Air Integration Kit		AI-56V	Power saving type of air compressor. The pump is not required.	●	●	●	●
Small Size Kit		SSK-56V	Minimum 105 mm or 4.13" width sheet can be fed. (Standard: 128 mm or 5.04")	●	●	●	●
Side Air Blower		SAB-56V	Side blowing assist air for stable feeding.	●	●	●	●
Extension Table		LT-56V	Maximum 1,100 mm or 43.3" sheet can be loaded. (Standard: 900 mm or 35.43")	●	●	●	●
Mark Sensor Kit		MS-56V	A camera scans the mark on sheets to identify any blank or misloaded sheets.	●	●	●	●
Mark Camera Kit		IMC-56V	A camera reads the end mark on sheets to separate the signatures.	●	●	●	●
Clear File		CLF-56V	This device controls the feed rotor to prevent sensitive stocks from being scratched.	●	●	●	●
Interface Unit		DIFV-56	Transports the sheets cut from the paper roll to the AFV-56S series.	●	●	No	No
Barcode Reader Kit		BR-56DF	Reads the data matrix to switch the fold pattern for dynamic folding.	●	●	No	No

We have various kinds of options and peripheral equipment other than the ones listed above. Please contact your local dealer for more information.

FP-56V / FP-56VP FRONT PERFORATION UNIT

- Accurate perforation before folding is ideal for direct mail applications and page tear out applications. Jump perforation is possible as an option. (Factory Option)



GFB-56V GATE FOLD BUCKLE

- The gate fold buckle can be set up quickly, with no special skill for precise, accurate closed gate folding.



IC-56V-U / IC-56V-L IMAGE CHECKER

- The camera verifies the image on the sheet with the preset image to identify any blank and misloaded sheets.



CGU-51 GLUING UNIT

- The gluing unit can produce 8-page or 12-page glued booklets and direct mail applications.

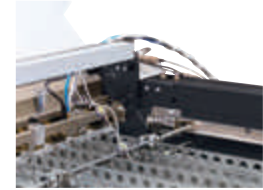

BLADES

- A wide variety of optional blades are available for various applications. (Blades in the photo are examples.)



- For optional FP-56V/FP-56VP. (Blades in the photo are examples.)

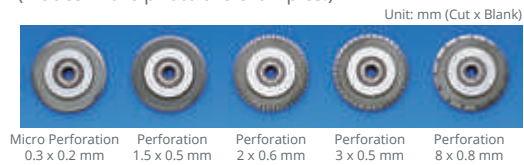

FOLDING / PERFORATION / SCORING SECTION

●: Retrofittable Options ○: Factory Options

NAME	MODEL	DESCRIPTION	AFV-566SF	AFV-564SF	AFV-566SA	AFV-564SA	TV-566SF	TV-564SF	
			●	○	●	○	○	○	
Selection	Steel and Soft-formed Polyurethane Combination Roller	RL-566VS	8 rollers for 6 buckle plate unit	○	No	○	No	○	No
		RL-564VS	6 rollers for 4 buckle plate unit	No	○	No	○	No	○
	Rigid Urethane Roller	RL-566VH1	8 rollers for 6 buckle plate unit	○	No	○	No	○	No
		RL-564VH1	6 rollers for 4 buckle plate unit	No	○	No	○	No	○
Front Perforation Unit	FP-56V	Removable metal anvil roller is used for front perforation unit. Only available as factory option.	○	○	○	○	No	No	
	FP-56VP	Removable resinous roller used for front perforation unit. Only available as factory option.	○	○	○	○	No	No	
Skip Perforation Unit	JM-AF	Perforation head for skip perforation	●	●	●	●	No	No	
Skip Perforation Control Unit	JM-C56V	Controller for JM-AF	○	○	○	○	No	No	
Cold Glue Unit	CGU-51	Gluing unit produces 8-page or 12-page glued booklets and direct mail applications.	●	●	●	●	No	No	
Gluing Unit Attachment Kit	CGU-K56V	A attachment kit for CGU-51	●	●	●	●	No	No	
Soft Polyurethane Roller with Groove	RL-CG56VS	Fold roller with groove in the center	○	○	○	○	No	No	
Segment Soft Polyurethane Roller	RL-SEG56VS	Segmented roller for adjustable gluing location	○	○	○	○	No	No	
Segmented Buckle Plate	SGB-56V	Segmented plate for adjustable gluing position	●	●	●	●	No	No	
Flat Deflector	FD-56V	Install to the buckle where the folding is not necessary.	●	●	●	●	●	●	
Image Checker	IC-56V-U	A camera scans the top surface of sheets to identify any blank or misloaded sheets.	●	●	●	●	No	No	
Image Checker	IC-56V-L	A camera scans the bottom surface of sheets to identify any blank or misloaded sheets.	●	●	●	●	No	No	
Gatefold Buckle	GFB-56V	Gate fold buckle to produce closed gate fold application.	●	●	●	●	●	●	
Bridge Conveyor	BGV-56	Bridge conveyor between the first and second station.	●	●	●	●	●	●	
Automated Bridge Conveyor	BGV-56BBS	Feed position sets automatically with the register guide on right-angled station for stable sheet transportation.	●	●	●	●	No	No	
Ionizer	INZ-DIFV	Ionizer to prevent the static electricity during the transportation from the interface conveyor DIFV-56	●	●	No	No	No	No	
	INZ-56V	Ionizer for smooth sheet transportation without any trouble with static electricity	●	●	●	●	No	No	

We have various kinds of options and peripheral equipment other than the ones listed above. Please contact your local dealer for more information.

OPTIONS.

Optional Units for the Delivery Section.

LCVV-56 LONG CONVEYOR

- A wide belt surface is capable of efficiently delivering any size folded piece.
- Conveyor height is easily adjusted to the proper sheet delivery height.
- Conveyor running mode can be set from the touch panel of the folder.



PSX-56 / PSX-56R PRESS STACKER

- Stacked signatures or booklets of a preset amount are delivered to a comfortable height for easy packaging. Rigid, large diameter rollers apply 1.2 tons of pressure for crisp, tight and flat folds. Applications can be stacked 1-up, 2-up or 3-up for efficient production.
- 20 job memory positions for easy recall of repeated jobs.



PSX-56

PST-66 / PST-44 / PST-44L PRESS STACKER

- First roller removes air between sheets and the second roller presses the sheets tightly to compress the folded pieces with 12,000N / 4,000N pressure for the PST-66 and PST-44/44L respectively.
- Specially coated press rollers achieve tighter fold quality for a wide range of applications such as signatures from thinner sheets, thicker sheets or even 16 page booklets.
- Offset delivery function for efficient production.
- Sheet width: Up to 690 mm or 27.1" for PST-66
Up to 470 mm or 18.5" for PST-44/44L
- The delivery conveyor of PST-44L is extended 300 mm compared to the PST-44.



PST-66

PR-40S PRESS ROLLER UNIT

- Strong and rigid press roller presses the folded sheets to form crisp tight folds. The press stacker can be used with the standing delivery unit ED-40S.

ED-40S STANDING DELIVERY

- Tightly folded pieces are vertically stacked for easy off-loading.
- An automatic batch kicker makes separation for easy counting.

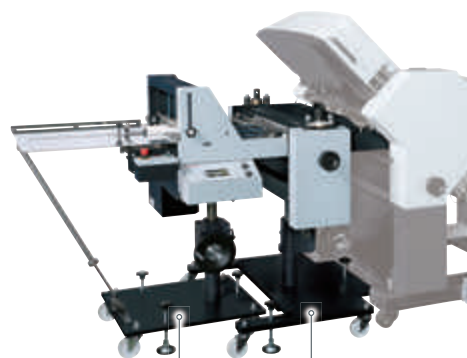

ED-40S

PR-40S

MKU-54T MOBILE KNIFE FOLD UNIT

- The MKU-54T is a mobile knife unit equipped with a buckle fold plate under the knife.
- Sheet width: 165 to 538 mm or 6.5" to 21.1"
- Letter fold and 8-page cross folds are possible.



MKU-38 MOBILE KNIFE FOLD UNIT

- Rotatable knife unit can fold up or down for a wide range of sheets from 90 to 380 mm or 3.6" to 14.9" width.



T-564A / T-566A BUCKLE UNIT

- A wide range of fold patterns such as map folds or face up and face down 16 page signature folding can be performed with this additional buckle station.
- Stand alone color touch screen enables set up of the folding buckle plates instantly with simple and intuitive operation.



DELIVERY SECTION

NAME	MODEL	DESCRIPTIONS	NOTES
Long Conveyor	LCVV-56	Standard delivery conveyor. The running mode can be set by the touch panel of the folder AFV-566FKT/564FKT.	
	LCV-54	Conveyor keeps moving when the folder stops.	
Press Stacker	PST-44 / PST-44L	0.4 tons of pressure can be applied to press and stack the signatures.	Adapter cable CMC-P5V15 is required.
	PST-66	1.2 tons of pressure can be applied for tighter fold quality.	
Press Stacker	PSX-56 / PSX-56R	Tightly pressed signatures, direct mailers or booklets are stacked and delivered at a comfortable height.	Adapter cable CMC-P4V is required.
Book Block Stacker	BBS-40 / BBS-40L	Signature book blocks are accumulated and tack glued for downstream processing.	Adapter cable CMC-P5V15 is required.
Standing Delivery	ED-40S	Small applications are delivered in the vertical posture for easy handling after delivery.	Adapter cable CMC-P3V is required. *Not required when connecting with the PR-40S.
Press Roller Unit	PR-40S	High performance press roller ensures crisp tight folds with 0.4 tons of pressure.	Adapter cable CMC-P3V is required.
Mobile Knife Fold Unit	MKU-54T	Mobile knife unit with buckle under the knife	Adapter cable CMC-P4V is required.
	MKU-38	Mobile knife unit for additional knife fold	
Buckle Unit	T-566A / 564A	Additional buckle station to maximize folding capabilities	Adapter cable CMC-P3V is required.

SPECIFICATIONS.

Machine Dimensions. (Unit: mm or inch)

Flexible modular concept increases folding capabilities.

CONFIGURATION 1

- Stand-alone 6-buckle

Stand-alone 6-buckle or 4-buckle configuration for brochure or leaflet folding.



AFV-56S series + LCVV-56

CONFIGURATION 2

- Right Angle 6/4 Buckle system

Buckle folding system is available with 4 or 6 buckle plates in both the parallel and right angle sections. Right angle configuration expands folding patterns for applications, including direct mail and book signatures. This configuration also allows for scoring in the first station and folding on the second station for heavier weight stocks.



AFV-56S series + TV-56S series + PST-44L

CONFIGURATION 3

- In-line 6/6 Buckle System

Straight 6/6 (4)-buckle modular system for maximum 10 or 12-buckle operation. Complex fold patterns can be performed with this configuration.



AFV-56S series + TV-56S series + PST-44L

	MODELS	NUMBER OF BUCKLES	AUTOMATION	ICE LINK
First Station	AFV-566SF	6	Full-automatic	Standard
	AFV-564SF	4	Full-automatic	Standard
	AFV-566SA	6	Full-automatic	Option
	AFV-564SA	4	Full-automatic	Option
Second Station	TV-566SF	6	Full-automatic	Standard
	TV-564SF	4	Full-automatic	Standard
	TV-566SA	6	Semiautomatic	Option
	TV-564SA	4	Semiautomatic	Option

* We cannot accommodate a change of number of buckles and type of automation after the shipment.

(Top View)

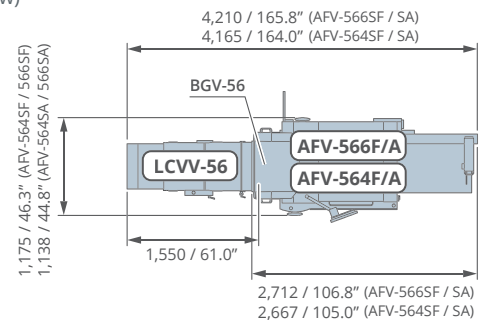

(Top View)

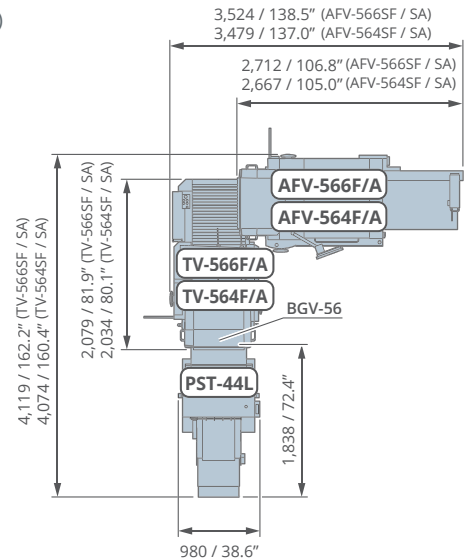

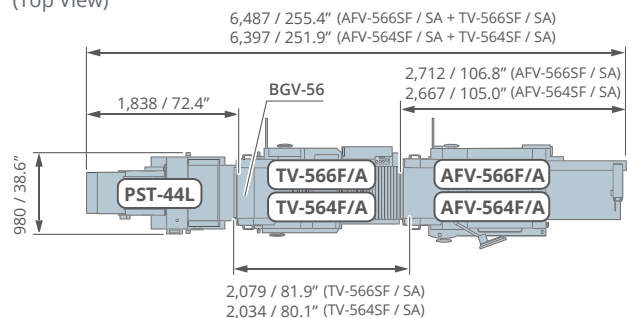

(Top View)





AFV-56S / TV-56S SERIES	
Machine Configuration	First Station AFV-566SF, 566SA: 6 Buckles, AFV-564SF, 564SA: 4 Buckles Second Station TV-566SF, 566SA: 6 Buckles, TV-564SF, 564SA: 4 Buckles
Sheet Size	Width x Length AFV-56S: Max. 560*1 x 900*2 mm or 22.04" x 35.43" Min. 128 x 148 mm or 5.04" x 5.83" * 105 mm or 4.14" with optional small size kit *1 : 558 mm or 21.965" with B-56C comb deflector buckle chute *2 : 1,100 mm or 43.310" with optional long table TV-56S: Max. 560 x 560 mm or 22.04" x 22.04" Min. 50 x 105 mm or 1.97" x 4.14" *Even if the sheet size is within the specification, it cannot be transported from the first station to the second station depending on the condition such as sheet type, fold pattern, and grain direction of sheet.
Sheet Weight Range	Uncoated Paper 40 to 250 gsm, Coated Paper 50 to 232 gsm
Belt Speed	30 to 270 meters per minute or 98 to 885 feet per minute
Production Speed	Suction Head 40,000 cycle per hour
Buckle Fold Length	AFV-56S 1st, 2nd, 3rd and 5th Buckle Chute: 30 to 450 mm or 1.19" to 17.71" 35 to 450 mm or 1.38" to 17.71" (with straight stopper) 4th and 6th Buckle Chute: 30 to 330 mm or 1.19" to 12.99" 35 to 330 mm or 1.38" to 12.99" (with straight stopper) TV-56S 1st, 2nd, 3rd, 4th and 6th Buckle Chute: 30 to 330 mm or 1.19" to 12.99" 35 to 330 mm or 1.38" to 12.99" (with straight stopper)
Voltage/Frequency	AFV-56S 3-phase 208 V, 60 Hz, 3-phase 200 to 230 V, 50 or 60 Hz 3-phase 380 or 400 or 415 V, 50 or 60 Hz (Step down to 200 V by Transformer) TV-56S 3-phase 208 V, 60 Hz 3-phase 200 to 230 V, 50 or 60 Hz
Machine Dimensions	AFV-566SF W2,715 x D1,180 x H1,530 mm or W106.9" x D46.5" x H60.3" AFV-566SA W2,715 x D1,140 x H1,530 mm or W106.9" x D44.9" x H60.3" AFV-564SF W2,670 x D1,180 x H1,530 mm or W105.2" x D46.5" x H60.3" AFV-564SA W2,670 x D1,140 x H1,530 mm or W105.2" x D44.9" x H60.3" TV-566SF W2,080 x D1,110 x H1,370 mm or W81.9" x D43.7" x H54.0" TV-566SA W2,080 x D1,110 x H1,370 mm or W81.9" x D43.7" x H54.0" TV-564SF W2,035 x D1,110 x H1,415 mm or W80.2" x D43.7" x H55.7" TV-564SA W2,035 x D1,110 x H1,415 mm or W80.2" x D43.7" x H55.7"

LCVV-56	
Signature Size	 Width x Length Max. 560 x 470 mm or 22.04" x 18.51" Min. 100 x 50 mm or 3.93" x 1.97"
Voltage	DC24V : Electricity supplied via folder connector
Machine Dimensions	Max. W1,550 x D705 x H1,080 mm or W61.1" x D27.8" x H42.6" Min. W1,220 x D705 x H780 mm or W48.1" x D27.8" x H30.7"

MKU-54T	
Signature Size	 Width x Length Max. 538 x 350 mm or 21.1" x 13.7" Min. 165 x 80 mm or 6.5" x 3.2"
Sheet Weight Range	Uncoated Paper 35 to 244 gsm
Belt Speed	50 to 180 meters per minute
Belt and Roller Gap	Fold Roller Section: Max. 2 mm or 0.024" *When making a letter fold using a A4 size booklet: Up to 3 sheets (12 pages) of normal paper of 81 gsm Up to 4 sheets (16 pages) of normal paper of 64 gsm
Buckle Fold Length	60 to 150 mm or 2.36" to 5.90" (Manual Setting)
Voltage/Frequency	Single Phase 208 to 240 V, 50 or 60 Hz
Machine Dimensions	W860 x D1,100 x H1,280 mm or W33.9" x D43.3" x H50.4"

MKU-38	
Signature Size	 Width x Length Max. 380 x 280 mm or 14.9" x 11.0" Min. 90 x 20 mm or 3.6" x 0.8"
Sheet Weight Range	Uncoated Paper 35 to 210 gsm
Belt Speed	30 to 180 meters per minute, 99 to 590 feet per minute
Belt and Roller Gap	Fold Roller Section: Max. 4 mm or 0.157"
Voltage/Frequency	Single Phase 200 to 240 V, 50 or 60 Hz
Machine Dimensions	W685 x D858 x H1,283.5 mm or W27.0" x D33.8" x H50.6"

	PST-66	PST-44 / 44L
Signature Size	 Maximum Width With Offset Delivery: 660 mm or 25.984" Without Offset Delivery: 690 mm or 27.165" (In either delivery, the maximum width is 380 mm or 14.96" when the extension belt section is used.) Minimum Length 50 mm or 1.969" (When the extension belt section is used)	Maximum Width With Offset Delivery: 440 mm or 17.322" Without Offset Delivery: 470 mm or 18.503" (In either delivery, the maximum width is 380 mm or 14.96" when the extension belt section is used.) Minimum Length 50 mm or 1.969" (When the extension belt section is used)
Signature/Booklet Thickness	Max. 4 mm or 0.15"	
Production Speed	Press Roller Speed: 30 to 180 m per minute	
Offset Amount	30 mm or 1.18"	
Number of Press Rollers	Air Remove Roller x 1, Press Roller x 1	
Voltage/Frequency	3-phase 200 to 220 V, 50 or 60 Hz Single Phase 200 to 240 V, 50 or 60 Hz	
Machine Dimensions	W2,145 x D1,159 x H1,359 mm or W84.5" x D45.7" x H53.6"	PST-44: W1,845 x D980 x H1,359 mm or W72.7" x D38.6" x H53.6" PST-44L: W2,145 x D980 x H1,359 mm or W84.5" x D38.6" x H53.6"

PSX-56 / PSX-56R	
Signature Size	 Width x Length Max. 546 x 330 mm or 21.496" x 12.992" Min. 128 x 92 mm or 5.04" x 3.622"
Signature/Booklet Thickness	Max. 4 mm or 0.15"
Stack Height	Max. 200 mm or 7.87" Min. 10 mm or 0.40"
Production Speed	Max. 900 stacks per hour (With continuous motion of the pushers)
Number of Press Rollers	Air Remove Roller x 1, Press Roller x 1
Voltage/Frequency	3-phase 200 to 220 V, 50 or 60 Hz Single Phase 200 to 240 V, 50 or 60 Hz
Machine Dimensions	W2,120 x D2,280 x H1,080 mm or W83.5" x D89.8" x H42.6"

PR-40S	
Signature Size	 Maximum Width : 400 mm or 15.74" Minimum Width : 30 mm or 1.19" Length : 25 mm or 0.99" *Note that even if the minimum length is 25 mm or 0.99" or above, depending on the opening amount of the signatures, the signatures can sometimes not be transported or delivered between the upstream/downstream devices.
Thickness of Folded Piece	Max. 3 mm or 0.12"
Belt Speed	30 to 180 meters per minute
Number of Press Rollers	Press Roller x 1
Voltage/Frequency	Single Phase 200 to 240 V, 50 or 60 Hz

ED-40S	
Signature Size	 Maximum Width : 400 mm or 15.74" Length : 150 mm or 5.90" Minimum Width : 30 mm or 1.19" Length : 20 mm or 0.79" *Note that even if the minimum height is 20 mm or 0.79" or above, depending on the opening amount of the signatures, the signatures can sometimes not be transported or delivered between the upstream device and the ED-40S.
Thickness of Folded Piece	Max. 3 mm or 0.12"
Stack Capacity	Max. 395 mm or 15.55", Min. 5 mm or 0.20"
Belt Speed	30 to 160 meters per minute
Offset Amount	Minimum Offset : Five sheets
Voltage/Frequency	Single Phase 200 to 240V, 50 or 60 Hz

*The machine design and specifications are subject to change without any notice.

*Specifications may vary depending on the job, paper quality, environmental influences, and various other factors. Please do a test run before starting production.