

Horizon

 iCE Series

BINDING

iCE BINDER BQ-300

Compact On-Demand Binding.



THE FUTURE OF ON-DEMAND BOOK PRODUCTION

Next level automation, user friendliness, and productivity that allows anyone to efficiently produce professional quality books.



BENEFITS

HIGH QUALITY

Enhanced automation and new features of the BQ-300 allow even non-skilled operators to produce high quality books. The new template feature helps automate various binder adjustments so that anyone can achieve efficient book-of-one production. Templates are created beforehand depending on style or substrate preferences and can be chosen at any time depending on job requirements.

EASY OPERATION & MAINTENANCE

The newly designed 15" control panel ("Horizon XUI") and increased mechanical automation help improve productivity by shortening setup time and eliminating touchpoints. New pullout delivery stacker allows for easier handling of bound books, while the front covers provide easy access to the inside for maintenance and cleaning.

HIGH PRODUCTIVITY

BQ-300 achieves up to 500 cycles per hour and achieves job changeover times that are up to 50% shorter than previous models. Additionally, enhanced variable thickness automation allows the BQ-300 to achieve efficient production even for short-run jobs.

SYSTEM EXTENSION CAPABILITIES

BQ-300 can be configured inline with a trimmer or robotic arm. The system can be enhanced with automated workflow from upstream to post-press with iCE LiNK. iCE LiNK is Horizon's cloud-based postpress management system that allows users to monitor production and machine status in real time, or automate their workflow by integrating finishing with their MIS and prepress.

NEW TEMPLATE FEATURE

Customized templates can be created according to desired book quality, paper type and other factors to produce consistent quality books with improved production efficiency and greater quality control.

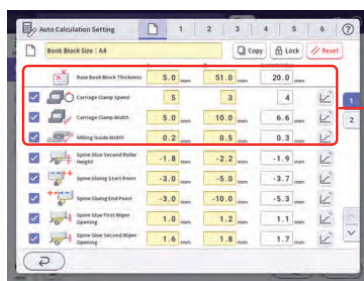

Fine Adjustment Value for Carriage Clamp

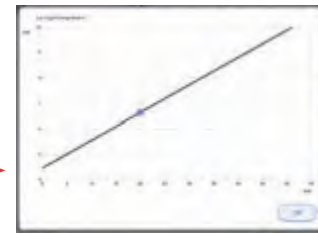

Book Block Thickness

To create a template, set-up for the thinnest book and thickest book and it automatically calculates the value in between.

DETAILED PROCESS FEATURES.

1 CONTROL PANEL DISPLAY



Newly equipped operation console "Horizon XUI" helps operators for easy setup. The 15" monitor with easily recognized icon enables intuitive operation during the setup. Almost all settings, including fine adjustments, can be set through the touchscreen.

2 BOOK THICKNESS CALIPER



Thickness data automatically begins setup of the clamp, milling, gluing, nipping table, and cover scoring rollers.

3 FEEDING SECTION

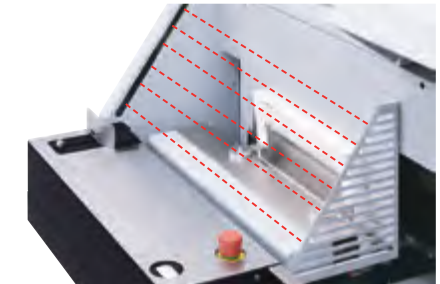

Clamp pre-opening is automatically adjusted according to the book block thickness. Increased clamp pressure for stable transportation of thicker book blocks and coated stock. This area features a light curtain for enhanced operator safety.

4 COVER FEED TABLE



The advanced rotary suction feed system insures fast, smooth feeding of various stock types without marking on the image. Adjustments for separation air can be automated from the touch panel for quick setup depending on the paper stock.

5 COVER REGISTRATION

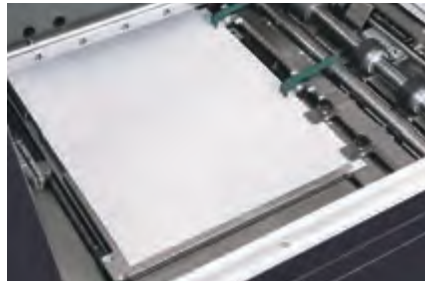

Top and bottom transport belts provide stable transportation of various cover types, and high-precision jogging mechanisms register the cover securely for consistent, quality binding.

6 MILLING DUST BAGS



Milling dusts are gathered in the trim bag. Placement can be done on either the book block feeding or cover feeding side for convenience. Utilize the new optional dust bag container to prevent milling dust from escaping the bag and being release into the air.

DETAILED PROCESS FEATURES.



Removable front operation cover for easy maintenance and cleaning.

9 GLUE TANK



Dual application rollers and side gluing rollers ensure superior glue application to the spine for quality binding.

The amount of glue applied and glue length can be adjusted through the color touchscreen. Adjustable temperature range widens and temperature quality control is more accurate for using variety of glue.

10 NIPPING SECTION



A strong, rigid nipping mechanism ensures binding quality with crisp spine quality.

7 COVER SCORING



Scoring is performed on thick covers for professional binding with sharp, square spines and hinge scores. The scoring width and position are automatically set-up according to book block thickness and cover registration.

8 MILLING SECTION



The rotary *leveling cutter and notching cutters mill the spine of a book block up to 51 mm or 2.0" thick, for optimum glue penetration and adherence. Milling depth can be adjusted from 0 to 4 mm or 0" to 0.15". The brush prevents milling chips from spreading to gluing section.

* Leveling Cutter: Mills the book spine.
Notching Cutter: Cuts grooves on the book spine to insure strong book binding.

11 DELIVERY SECTION



The finished books are delivered to a vertical stacker located just below the book feeding station. This allows a single operator to easily check the quality of finished books while continuing production. The vertical stacker can be pulled out for efficient off loading the bound books.

OPTIONS.

| VS-280 FUME EXTRACTOR

- The strong blower provides constant fume extractions for a comfortable operating environment. It runs for 30 minutes to keep the environment clean after finishing the operation on BQ-300 and it automatically powers off.

*Sufficient space required for air circulation



| BC-BQ300-1D/2D MATCHING SYSTEM

- Verify that cover and book block match by scanning code for secure operation.



Scanning code on book blocks

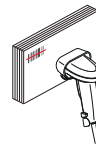

Verify

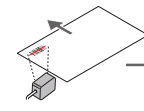

Scanning code on cover

Operation screen



When codes are matched

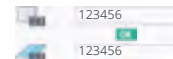

When codes are not matched

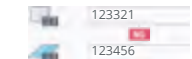

| T-BQ300 WEEKLY TIMER

- T-BQ300 weekly timer automatically switches power on from control panel at pre-set times for quick make-ready. Time and day of the week can be set.



| RFS-BQ300 JOGGING UNIT

- Automatic jogging unit for book block to be registered on right side in the clamber.

*Required when robot arm is configured.

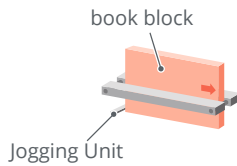

| DV-270L-A/DV-270L-B DELIVERY CONVEYOR

- Slope conveyor to transport books to the height of infeed section of HT-300.



| DV-270 DELIVERY CONVEYOR

- The delivery conveyor lifts the books to a convenient height for easy unloading.

*Required for standalone usage.



OPTIONS.

OPTION LIST

NAME	MODEL	DESCRIPTIONS	
Fume Extractor	VS-280	The strong blower provides constant fume extractions for a comfortable operating environment.	
Extension Unit	Selection EU-BQ300-2D	Required when BC-BQ300-2D is installed.	
Flap Cover Kit		FLP-BQ300	Flap cover kit for making another two scoring lines. Scoring position adjusts automatically.
Jogging Unit	RFS-BQ300	Automatic jogging unit on feeding. *Required when robot arm is configured.	
Weekly Timer	T-BQ300	Weekly timer automatically switches power on from control panel at pre-set times for quick make-ready.	
Delivery conveyor	Selection DV-270 DV-270L-A DV-270L-B	DV-270	Delivery lift conveyor to stack efficiently. *Required for standalone usage.
		DV-270L-A DV-270L-B	Slope conveyor for inline connection with three-knife trimmer.
Pre-melter	Selection PM-20II PM-20L	PM-20II	For EVA hotmelt glue with 2.5m length hose 18L tank capacity.
		PM-20L	For EVA hotmelt glue with 4.5m length hose 18L tank capacity.
Premelt Tank Connecting Kit	CN-BQ300	This is required to connect the PM-20L/LN with the BQ-300.	
Scoring Wheel	C-480c-7	7mm scoring wheel for spine edge and hinge scoring.	
	C-480c-8	8mm scoring wheel for spine edge and hinge scoring.	
1D code matching system	BC-BQ300-1D	1&2D code available for book blocks and only 1D code available for cover sheet. Available 1D code : CODE39, CODE128, EAN, JAN. 2D code : DataMatrix(ECC200), QR code.	
2D code matching system	BC-BQ300-2D	1&2D code available for both book blocks and cover sheet. *EU-BQ300-2D or FLP-BQ300 is required. Available 1D code : CODE39, CODE128, EAN, JAN. 2D code : DataMatrix(ECC200), QR code.	
Handy Code Scanner	HBR-2D	For recalling job from the memory by scanning code.	
Trim Bag Box	TBB-BQ300	Container for milling dust bag to prevent milling dust from escaping the bag.	

ROBOT ARM BOOK PRODUCTION SYSTEM

Labor shortages, rising costs and inefficient workflows are common issues of modern-day printing. Robot System could be the solution for these issues.

BOOK BLOCK FLOW

*The following configuration is an example. System configuration and layout will change depending on the customer's needs.
*Refer to brochure for the details of each unit.

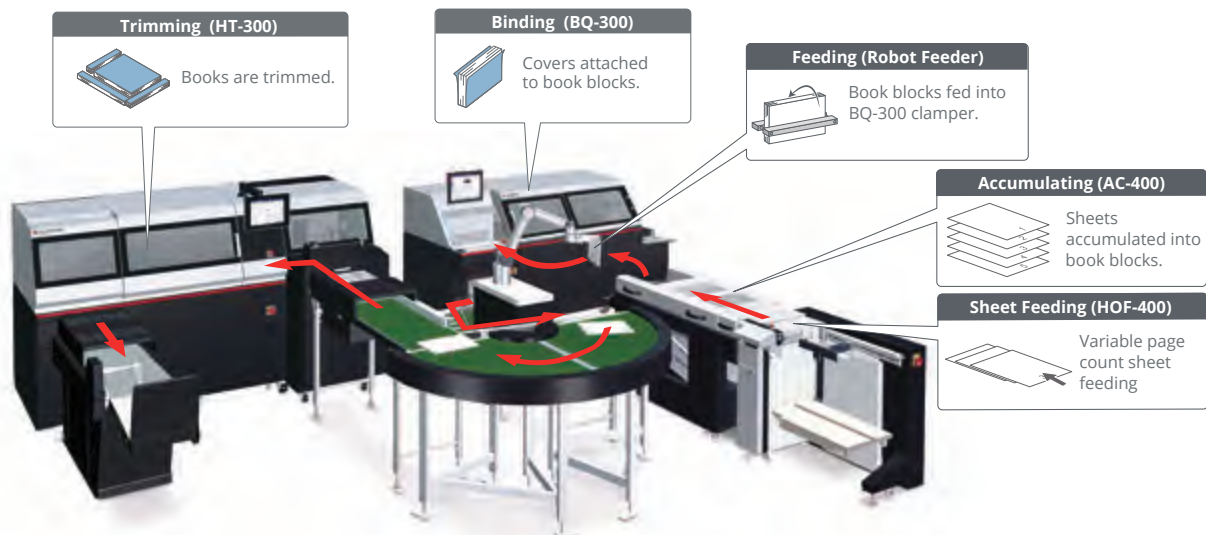

SPECIFICATIONS.

Machine Dimensions. (Unit : mm or inch)

BQ-300

(Front View)

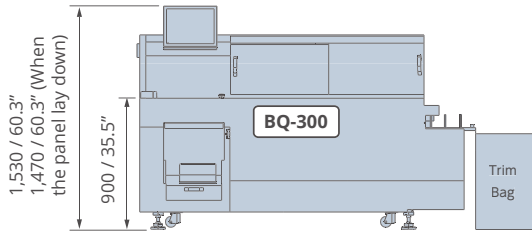

(Top View)

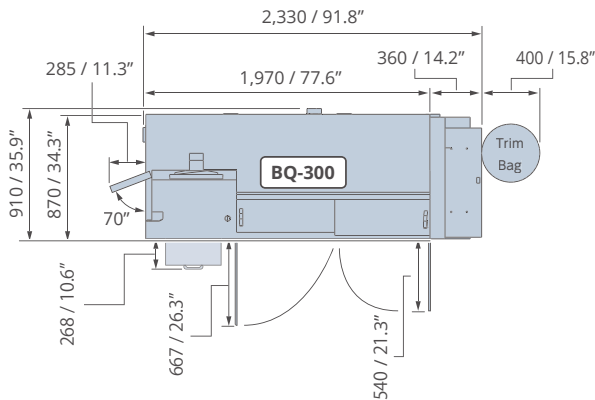

BQ-300	
Binding Type	Binding with milling, Binding without milling, and Pad binding
Number of Carriage Clamps	1
Book Block Size	Spine Length × Fore-edge Length
	Max. 320 × 320 mm or 12.59" × 12.59" Min. 135 × 105 mm or 5.32" × 4.14"
	A4 / B5 / A5 / B6 / A6
Book Block Thickness	1 to 51 mm or 0.04" to 2.00"
Cover Size	Length × Width
	Max. 320 × 660 mm or 12.59" × 25.98" (up to 350 mm or 13.77" forwards from the clamp face) (up to 310 mm or 12.20" backwards from the clamp face) Min. 135 × 225 mm or 5.32" × 8.86" mm (up to 115 mm or 4.53" forwards from the clamp face) (up to 110 mm or 4.34" backwards from the clamp face)
Cover Weight Range	Normal Paper 81.4 to 302.4 gsm Coated Paper 104.7 to 348.9 gsm
Cover Stack Height	Max. 70 mm or 2.75"

HOF-400 + PJ-77 + ROBOT FEEDER + BQ-300 + HT-300

(Top View)

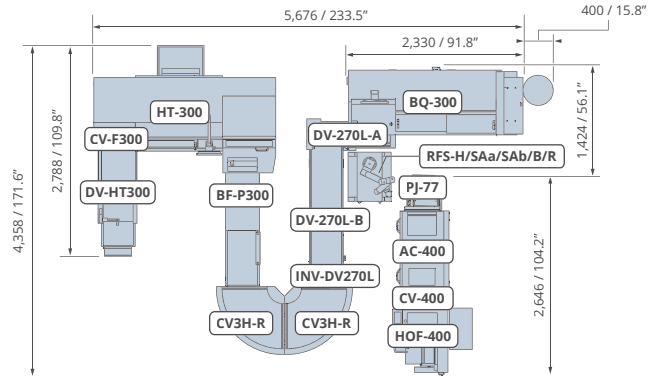

(Top View)

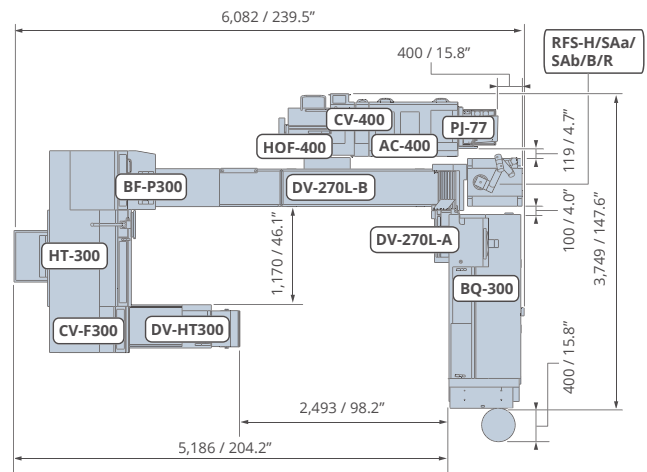

Glue Temperature	120 to 190 degrees Celsius or 248 to 374 degrees Fahrenheit
Milling Depth	Max. 4 mm or 0.157" (Adjustable in increments of 0.5 mm or 0.02".)
Cycle Speed	Max. 500* cycles per hour.
Voltage / Frequency	3-phase 200 to 220 V, 50 or 60 Hz 3-phase 208 V, 50 or 60 Hz 3-phase 220 to 230 V, 50 or 60 Hz 3-phase 400 V, 50 or 60 Hz * An external transformer is necessary for 220 to 230 V or 400 V.
Machine Dimensions	2,330** (W) × 910 (D) × 1,530 (H) mm or 91.74" (W) × 35.83" (D) × 60.24" (H) (This dimension is measured including the parts protruding from the cover.) *See the installation manual for the dimensions of the machine with the cover feeder and covers removed.
Machine Weight	Only the Main Body: 970 kg or 2,138.49 lb

* The production speed changes depending on the operator's working speed and the job settings
** When the FLP-BQ300 or EU-BQ300-2D is installed, the width is extended by 100 mm or 3.94".

MORE AT
HORIZON.CO.JP



Horizon

Horizon International Inc.

1601 Asahi, Shinasahicho, Takashima,
Shiga, 520-1501, Japan
Phone : +81-740-25-4570
Fax : +81-740-25-5820
www.horizon.co.jp

Distributed by

 **STANDARD**

Standard Finishing Systems

10 Connector Road, Andover,
MA 01810
Phone : 877-404-4460 / 978-470-1920
Fax : 978-470-2771
www.standardfinishing.com