

Horizon

VAC-1000/VAC-600H

Air-Suction Collator

**World fastest collator in this class.
Programmed collating function.**



Horizon's unique rotary suction feeding system operates effectively on a wide range of paper stocks. The VAC-1000/VAC-600H towers can also be placed in-line with Horizon bookletmaking systems.

The VAC-1000/VAC-600H takes advantage of Horizon's unique feeding technology and continues the Horizon development concept of "high speed", "high performance" and "high quality". The VAC-1000/VAC-600H performs a wide range of applications at high productivity, with flexible but powerful programming and user-friendly operation.



VAC-600H (12 bins) + ST-20 + PJ-77R

Features

User-friendly operation by color touchscreen and wireless remote control

A large color touchscreen is icon-based for user-friendly operation. The graphical screen guides the user through all set-up procedures with ease. Frequently operated buttons are arranged on a wireless remote control, which is included as standard. The remote provides for collating speed adjustment and start/stop/jog operation, and lets you monitor the feeding or delivering condition.



All displayed in the touchscreen
Double feeding, misfeeding or sheet jamming are individually displayed for all bins. If any errors occur, a description and location of the problem are displayed and the machine will stop.

Reliable sensing capability

High-power double feed detect sensor

High-intensity infrared LED's are employed at each bin for double feed detection. These long-lasting LED's save the time and cost of replacing individual lamps.

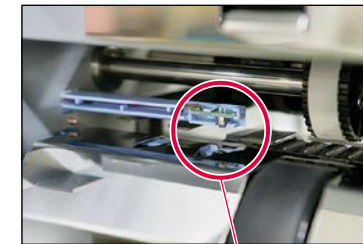

Double Feed Detect Sensor

Image checking system IC-VAC600H

Option (Only for VAC-600H)

The VAC-600H can be equipped with an image checking camera. This checking system stores and checks the printed image of each page on each feed cycle to insure page order and integrity. The camera is housed in the transport section for space efficiency.

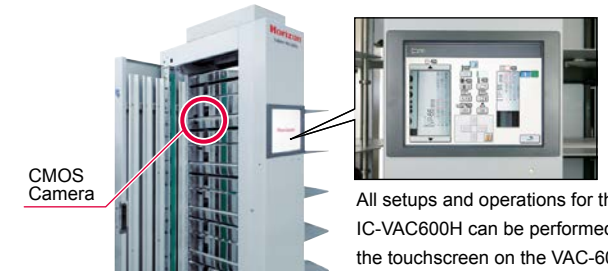

All setups and operations for the IC-VAC600H can be performed through the touchscreen on the VAC-600H.

New powerful blower for reliable feeding

The new Horizon blower is 33% more powerful than conventional collator blowers. Vacuum air and blower air can be individually adjusted for a wide range of paper qualities and sizes.



Connectable to VAC-100/VAC-60H

The VAC-1000 can be connected to existing VAC-100, and the VAC-600H can be connected to existing VAC-60H towers. * Retrofit of the VAC-100 or VAC-60H may be necessary.

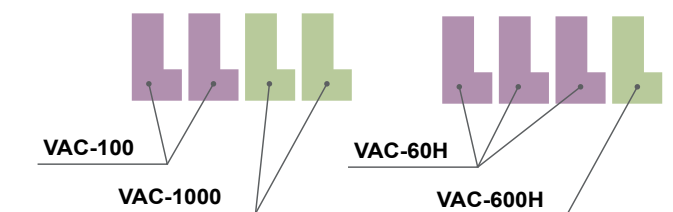

Wide choice of receiving trays

Choose between the criss-cross receiving tray for signatures, or the stacker receiving tray for large volume collated sets. An optional paper jogger is also available.

Connectable to bookletmaking system

The VAC-1000/VAC-600H can be connected to Horizon bookletmakers to form a complete in-line bookletmaking system.

Further Details of VAC-1000/VAC-600H

Module Configuration and Features

- Tower a : Front module with the touchscreen display.
- Tower m : Extension module without the touchscreen display.
- Tower C : Rear module with the touchscreen display. (Necessary for right side delivery)



Reliable suction rotor feeding

Horizon's unique suction rotor feeding system can feed a wide variety of paper stocks. Even signatures can be fed consistently. The feed wheel employs a special, highly durable rubber for totally mark-less feeding. Feed height sensors and air blowers enable a broad range of sheets to be fed with ease.



Suction feed section on a bin
Stable feeding capability for a wide range of sheets.

What is suction rotor feeding?

Air is blown into the stack to float the sheets. The air rotor then picks-up the top sheet and rotates to advance the sheet.

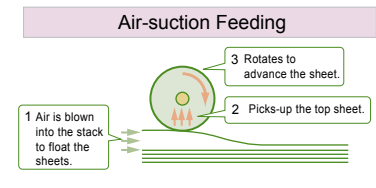

High speed and continuous collating

The VAC-1000 can collate using 10 bins in a single tower. Maximum 6 towers can be connected for a 60-bin system. Sheets can be piled up to 130 mm in each bin of the VAC-600H to reduce bin loading time. This provides the operator with ample time to prepare stock for reloading.

Model	Max. Number of Bins	Bin Pile Height	Production Speed	Continuous Running Time ^{*3}
VAC-1000	60 bins (6 towers)	55 mm (2.16")	9,900 sets/hr. ^{*1}	6.6 min
VAC-600H	36 bins (6 towers)	130 mm (5.11")	9,900 sets/hr. ^{*2}	15.6 min

^{*1} A5LEF, Straight receiving on 10 bins

^{*2} A5LEF, Straight receiving on 6 bins

^{*3} When running with 5,000 sets/hr. collating 80 gsm normal paper

Efficient programming functions

The VAC-1000/VAC-600H is equipped with advanced programming functions for easy and efficient collating.

Double Cycle

When any bin in the first collator section empties, the system immediately switches over to the second section and continues collating. This maximizes efficiency by giving the operator ample time to prepare stock for reloading.



Dual Cover Feed

The top two bins are prepared for feeding covers. When one cover bin empties, the collator automatically switches over to the other cover bin.



Preset Tabbing

Up to 2 tab sheets can be inserted to every pre-set collation. Especially useful for inserting two sheets as front and back covers.

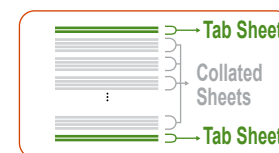

Left and right side delivery^{*4}

The operator can run sets into the bookletmaking system at the left side, while at the same time collating straight sets into the receiving tray on the right side of the system. The right side delivery is useful for collating reverse-numbering jobs because the sheets are turned over during transport.

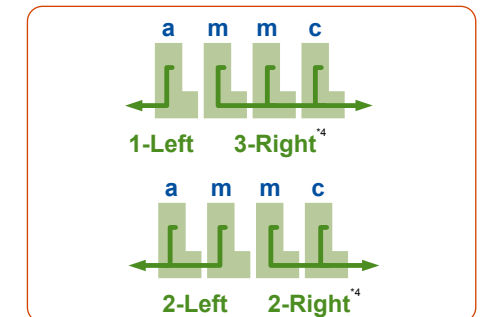

^{*4} The tower c is necessary for right side delivery.

Memorize frequent job settings

Collating speed, type of program used, number of bins used, and sensor sensitivity settings are stored in the system memory for quick restart of regular job. Up to 9 different jobs can be memorized.

Optional Accessories

Wide variety of options are available

Criss-Cross Receiving Tray CCR/CCR-DX

Selection

The criss-cross receiving tray swings 90 degrees at each collating interval, clearly separating collated sets to simply post-collating processes. This is also suitable for piling sets onto previously collated sets.

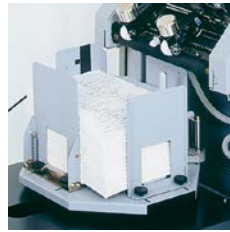

Paper Jogger PJ-77

Option

Driven by an independent motor, the paper jogger vibrates collated sheets into perfect alignment. The jogger tray rises automatically by a foot switch to start collating.

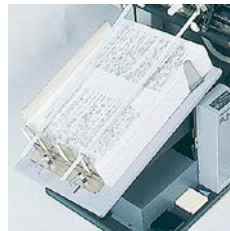

Bypass Stacker ST-40

Option

Errored sets are delivered to the built-in reject tray for non-stop operation. Connected between the collating and bookletmaking systems, the ST-40 serves as a high-capacity offset or straight stacking device.

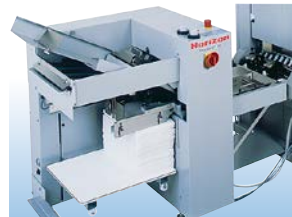

Sub Accumulator SA-40

Option

The SA-40 can be connected between the collator and the ST-40. The SA-40 accumulates the sheets delivered from the collator and stabilizes the sheet jog for the stitcher for quality bookletmaking.



a-Tower Kit CTK-100

Option

The a-tower kit is required for a-towers to deliver to the right side. This kit is not required for the right side delivery on the c-tower.



Hand-Marry Unit HMU-100

Option

The hand-marry unit can be connected to maximum 2 towers.
Possible Booklet Size: Max. 350 x 500 mm (13.77" x 19.68")
Min. 120 x 148 mm (4.78" x 5.83")
Thickness: Max. 80 gsm normal paper, 50 sheets (5 mm/0.20")
Min. 80 gsm normal paper, 1 sheet (0.1 mm/0.004")
The HUM-100 cannot be connected to the c-tower.

Stacker Receiving Tray ST-20

Selection

The stacker receiving tray shifts each collated set laterally, separating the collated sets. When an empty pallet is presented, the stacker rises to its home position to start collating.



Stacker Receiving Tray for Right Side Delivery ST-20R

Option

The stacker receiving tray shifts each collated set delivered on the right side laterally.



Paper Jogger for Right Side Delivery PJ-77R

Option

The paper jogger vibrates collated sheets delivered on the right side into perfect alignment.



Tandem Stacker ST-60

Option

The twin-tray design delivers 8,000 sets per hour as neatly jogged off-set stacks. When one stack tray becomes full, the sets automatically route to the other stack tray, with no system slowdown.



Bypass Conveyor BC-20

Option

The BC-20 can be connected with the collators and receiving trays (CCR/CCR-DX) all together. The BC-20 switches over from bookletmaking to stacking with simple push of a button.



Extra Air Blower for Separation Air EAB-1000

Option (Only for VAC-1000)

The EAB-1000 improves the feeding operation with coated paper.

Dimensions: 580(W) x 230(D) x 320(H) mm (22.9" x 9.1" x 12.6")

A4 Landscape Kit LG-1000

Option (Only for VAC-1000)

LG-1000 landscape guide enables to load the sheet length up to 610mm (24") for A4 landscape booklet production.

Advanced bookletmaking system solution

Option

Saddle-stitching System StitchLiner5500

The Horizon StitchLiner5500 is an innovative saddle-stitching system which incorporates flat sheet collating, scoring, folding, stitching and three-knife trimming in line. Folding is performed in-line to simplify the saddle-stitching workflow and improve operational efficiency. With high productivity and quick-changeover, the StitchLiner5500 is ideal for short, medium and long production runs.

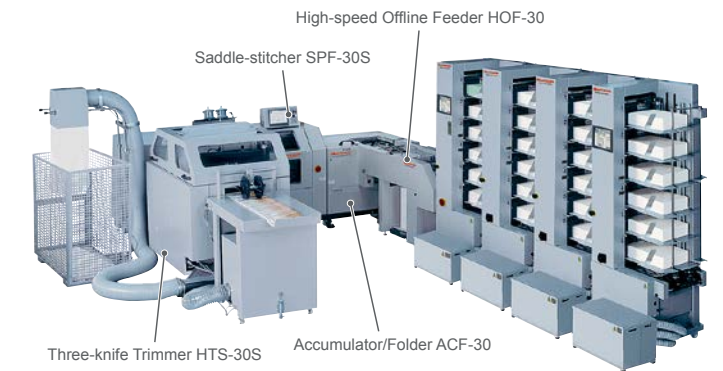

Bookletmaking System SPF-200A+FC-200A

High performance in-line bookletmaking system with collating, stitching, folding and fore-edge trimming. All necessary settings can be performed automatically through the touchscreen display. Even the fold roller gap adjustment is automated. Maximum production speed is 4,500 books per hour with A5 booklets.

Hole Punch Unit HP-200A

High speed hole punching can be performed without any production slow-down of the SPF-200A. Hole punch, press and through modes can be selected for efficient in-line bookletmaking production.



High-speed Offline Feeder HOF-30

When connected with VAC-series collators, the HOF-30 is a flexible finishing solution serving both digital and offset printing. For digital work, the HOF-30 is a high-speed sheet feeder while the VAC-series collator provides cover inserting. When the VAC-series collator is feeding offset work, the HOF-30 serves as a bypass conveyor and reject tray for nonstop production.



Corner Stitching Unit SP-1

The SP-1 performs angle stitching on the corner. The machine will stop if miscollating occurs to avoid producing a bad booklet.

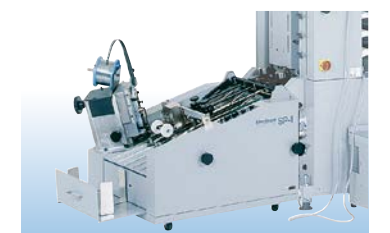

VAC-1000 Major Specifications

Module Type	VAC-1000a, VAC-1000m, VAC-1000c					
Number of Bin	10 bins	20 bins	30 bins	40 bins	50 bins	60 bins
Sheet Feeding System	Suction Rotor Feeding System					
Sheet Size	Max. 350(W) x 500(L) mm (13.77" x 19.68") Min. 148(W) x 148(L) mm (5.83" x 5.83") Machine can collate the sheet of 120 mm (4.73") width when option guide is attached.					
Sheet Weight Range	Coated Paper: 74 to 210 gsm (20 to 55 lbs) Normal Paper: 53 to 210 gsm (14 to 55 lbs) 8-page fold signature: up to 105 gsm (27 lbs)					
Bin Pile Height	Max. 55 mm (2.16")					
Sheet Overlap	4 steps					
Production Speed	10 bins	Max. 9,900 sets/hr. (A5LEF, Straight Receiving) Max. 8,900 sets/hr. (A4LEF, Straight Receiving) *Production speed is limited by the type of finisher or sheet weight.				
	20 bins	Max. 6,900 sets/hr. (A4LEF, Straight Receiving)				
	30 bins	Max. 6,400 sets/hr. (A4LEF, Straight Receiving)				
	40 bins	Max. 5,000 sets/hr. (A4LEF, Straight Receiving)				
	50 bins	Max. 4,500 sets/hr. (A4LEF, Straight Receiving)				
	60 bins	Max. 4,000 sets/hr. (A4LEF, Straight Receiving)				
Voltage / Frequency	Single Phase, 208 / 220 / 230 / 240 V, 50 / 60 Hz 3-phase 220 V is also available.					
Machine Dimensions (Blower included)	Width 934 mm (36.8")	Width 1,744 mm (68.7")	Width 2,554 mm (100.6")	Width 3,364 mm (132.5")	Width 4,174 mm (164.4")	Width 5,088 mm (200.4")
	Depth 992 mm x Height 1,962 mm (39.1" x 77.3")					

VAC-600H Major Specifications

Module Type	VAC-600Ha, VAC-600Hm, VAC-600Hc					
Number of Bin	6 bins	12 bins	18 bins	24 bins	30 bins	36 bins
Sheet Feeding System	Suction Rotor Feeding System					
Sheet Size	Max. 350(W) x 500(L) mm (13.77" x 19.68") Min. 120(W) x 148(L) mm (4.78" x 5.83")					
Sheet Weight Range	Coated Paper: 74 to 210 gsm (20 to 55 lbs) Normal Paper: 53 to 210 gsm (14 to 55 lbs) 8-page fold signature: up to 105 gsm (27 lbs)					
Bin Pile Height	Max. 130 mm (5.11")					
Sheet Overlap	4 Steps					
Production Speed	6 bins	Max. 9,900 sets/hr. (A5LEF, Straight Receiving) Max. 9,600 sets/hr. (A4LEF, Straight Receiving) *Production speed is limited by the type of finisher or sheet weight.				
	12 bins	Max. 7,000 sets/hr. (A4LEF, Straight Receiving)				
	18 bins	Max. 6,600 sets/hr. (A4LEF, Straight Receiving)				
	24 bins	Max. 5,000 sets/hr. (A4LEF, Straight Receiving)				
	30 bins	Max. 4,500 sets/hr. (A4LEF, Straight Receiving)				
	36 bins	Max. 4,000 sets/hr. (A4LEF, Straight Receiving)				
Voltage / Frequency	Single Phase, 200 / 208 / 220 / 230 V, 50 / 60 Hz Single Phase, 240 V, 50 Hz 3-phase 220 V is also available.					
Machine Dimensions (Blower included)	Width 934 mm (36.8")	Width 1,744 mm (68.7")	Width 2,554 mm (100.6")	Width 3,364 mm (132.5")	Width 4,174 mm (164.4")	Width 5,088 mm (200.4")
	Depth 992 mm x Height 1,962 mm (39.1" x 77.3")					

Available Receiving Trays

Name	Model	Sheet Size / Receiving Tray Capacity
Criss-Cross Receiving Tray Selection	CCR CCR-DX	Max. 320(W) x 470(L) mm (12.59" x 18.50") Min. 148(W) x 210(L) mm (5.83" x 8.27") A5 - A4: 170 mm (6.7") / A4 - A3: 100 mm (4.0")
Stacker Receiving Tray Selection	ST-20	Max. 320(W) x 450(L) mm (12.59" x 17.71") Min. 128(W) x 182(L) mm (5.04" x 7.17")
For right side delivery Option	ST-20R	320 mm (12.6")
Paper Jogger Option	PJ-77	Max. 320(W) x 460(L) mm (12.59" x 18.11") Min. 128(W) x 182(L) mm (5.04" x 7.17")
For right side delivery Option	PJ-77R	110 mm (4.4")
Bypass Stacker Option	ST-40	Max. 350(W) x 500(L) mm (13.77" x 19.68") Min. 182(W) x 128(L) mm (7.17" x 5.04") 360 mm (14.1")
Tandem Stacker Option	ST-60	Max. 350(W) x 500(L) mm (13.77" x 19.68") Min. 182(W) x 128(L) mm (7.17" x 5.04") Receiving Tray A (R) 360 mm (14.1") Receiving Tray B (L) 580 mm (22.8")

Finishing Devices Option

Name	Model
Saddle-stitching System	StitchLiner5500 (ACF-30+SPF-30S+HTS-30S)
Bookletmaking System	SPF-200A+FC-200A
Bookletmaking System (Hole Punch Unit connected)	SPF-200A+HP-200A+FC-200A
Bookletmaking System (Hole Punch Unit connected)	SPF-20+FC-20
Corner Stitching Unit	SP-1
High-speed Offline Feeder	HOF-30
Sub Accumulator	SA-40
Bypass Conveyor	BC-20

Machine Dimensions Unit : mm (inch) *VAC-1000 and VAC-600H are in the same dimensions.

Height : 1,962 (77.3")

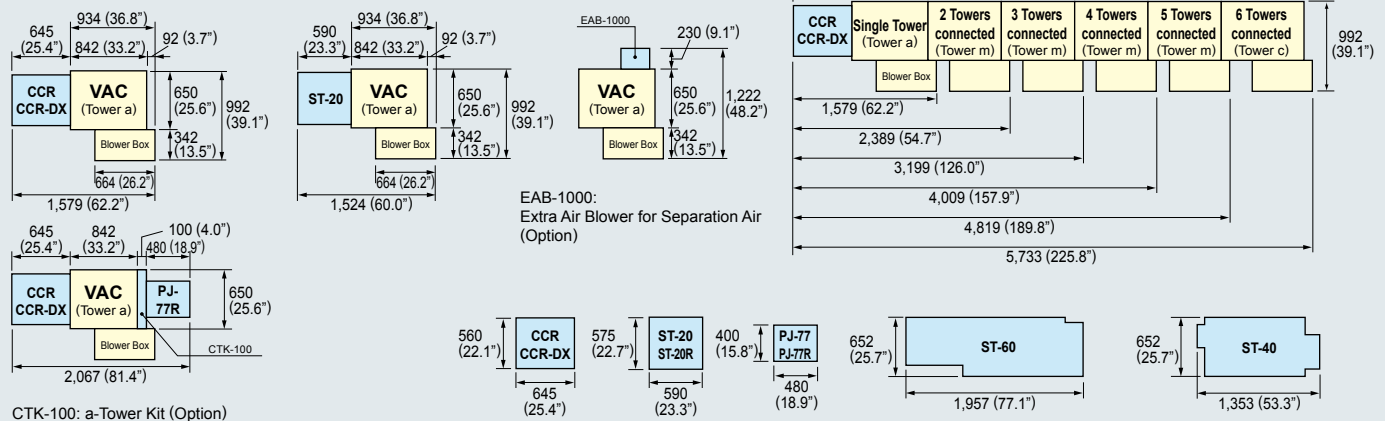

*The machine design and specifications are subject to change without any notice.